



1511-10
N.3
12.5cm

1511-10-A
No.3
12.5cm

1511-11
N.4
13.5cm

1511-14
N.5
14.5cm

1511-15
N.5A
14.5cm

1511-18
N.7
16.5cm

1511-20
Long Handle
16cm
Adjustable In 7
Positions & 180°

1511-22
Drop Blade Scalpel Handle
16cm
Automatic Blade
Remove



1511-110
N.10



1511-111
N.11



1511-112
N.12



1511-112D
N.12D



1511-113
N.13



1511-115
N.15

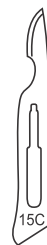

1511-115C
N.15C

Steril scalpel blades N.3 in package of 100 pcs



1511-36
13.5cm



1511-36TM
Titanium
13.5cm



1511-50



1511-52



1511-54



1511-56

Microblades In Package Of 25 Pcs

Blade Remover



1511-60
Scalpel Blades
Remover
16cm



- Example Of Application**
- 1** 1 Blade To Be Seized Here;
 - 2** 2 Then Lift It Here;
 - 3** 3 Finally Pull It Off In Forward Direction



1511-68
Razor Blade Breaker
and Holder
12.5cm

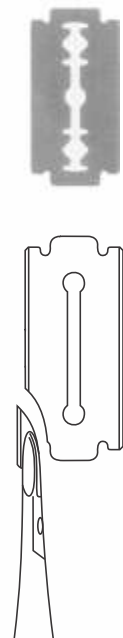



1512-11
9cm
Curved

1512-10 9cm
Micro Iris Straight



1512-13
11.5cm
Curved

1512-12 11.5cm
Iris Straight



1512-16 12cm
Iris Angular 45°

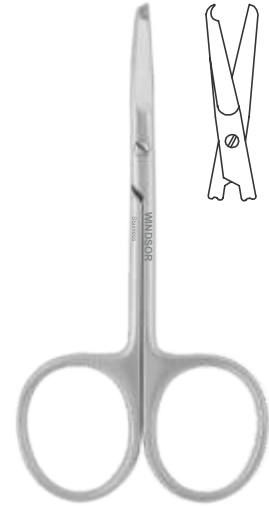

1512-18 11.5cm
1512-19 13cm
Spencer



1512-23
14cm
Curved

1512-22
Joseph
1 Serrated Blade 14cm
Straight

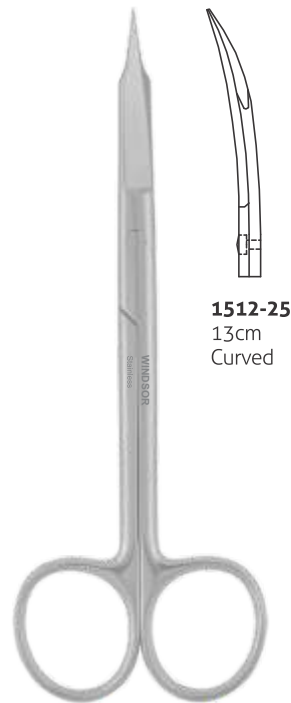

1512-25
13cm
Curved

1512-24
Goldman-fox
Saw Edge 13cm
Straight



1512-26
Goldman-fox
Saw Edge 13cm
Double Curved

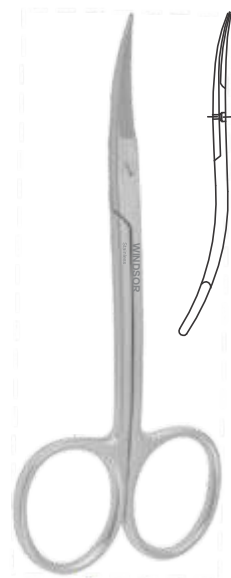

1512-27
La Grange
Saw Edge 11.5cm
Double Curved



1512-31 13cm
1512-33 14.5cm
Curved

1512-30 13cm
1512-32 14.5cm
Blunt-Sharp Straight



1512-35 13cm
1512-37 14.5cm
Curved

1512-34 13cm
1512-36 14.5cm
Blunt-Blunt Straight



1512-43 14cm
1512-45 17cm
Curved

1512-42 14cm
1512-44 17cm
Mayo Straight



1512-51 14.5cm
1512-53 18cm
1512-55 20cm
Curved

1512-50 14.5cm
1512-52 18cm
1512-54 20cm
Metzenbaum Straight



1512-59 12cm
1512-61 15cm
1512-63 18cm
Curved

1512-58 12cm
1512-60 15cm
1512-62 18cm
Kilner Straight



1512-65 16cm
Curved

1512-64 16cm
Kelly Straight



1512-70 14cm
1512-72 18cm
Lister Bandage Scissor



1512-74 14.5cm
1512-76 18cm
Lister Bandage Scissor



1512-81
10.5cm
Curved

1512-80
10.5cm
Straight



1512-83
10.5cm
Curved

1512-82
10.5cm
Straight



1512-84 17cm
Dean Angular
Saw Edge



1512-86 13cm
1512-88 16cm
Locklin Angular



1512-91
Curved
11cm

1512-90
Beebee 11cm
Saw Edge Straight



1512-93
Curved
11cm

1512-92
Beebee 11cm
Saw Edge Straight



1512-91T
Curved
11cm

1512-90T
Beebee 11cm
Saw Edge Straight



1512-93T
Curved
11cm

1512-92T
Beebee 11cm
Saw Edge Straight



1513-11T
11.5cm
Curved

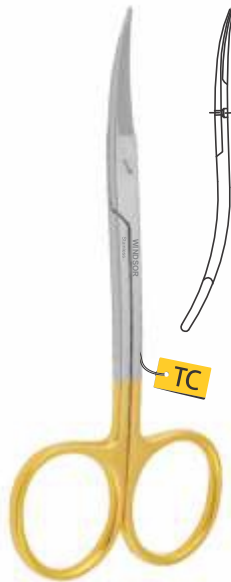

1513-14T 11.5cm
La Grange Double Curved
Saw Edge



1513-16T 13cm
Goldman-Fox Straight
Saw Edge



1513-20T 13cm
Goldman-Fox Double Curved
Saw Edge



1513-22T 16cm
Kelly Straight

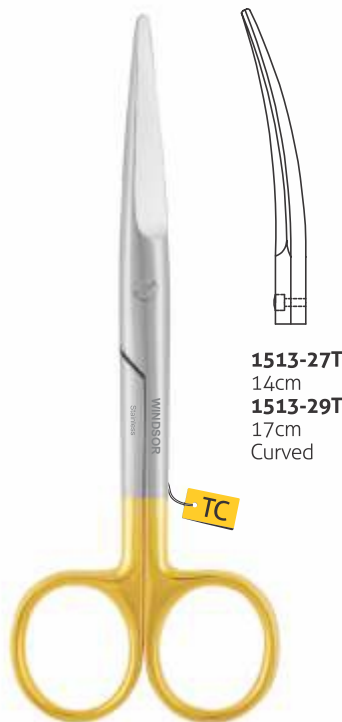

1513-26T 14cm
1513-28T 17cm
Mayo Straight



1513-32T 14.5cm
1513-34T 18cm
1513-36T 20cm
Metzenbaum Straight

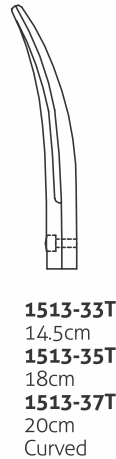

1513-33T 14.5cm
1513-35T 18cm
1513-37T 20cm
Curved

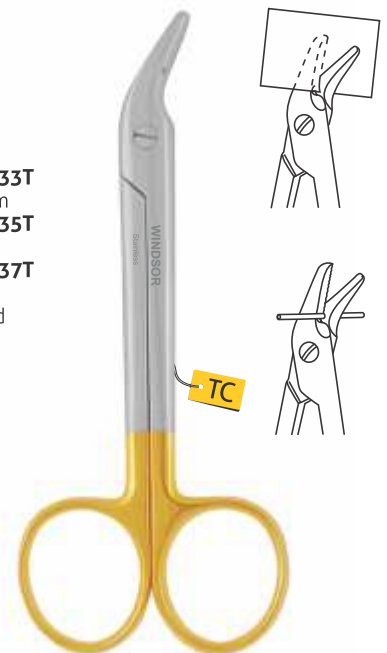

1513-40T 12cm
Universal Wire Cutting Scissor

Super Cut Scissors Are Manufactured With Special Sharpening Process. Razor Sharp Blade On One Side and Fine Serrations On Opposite Blade Extremely Useful For Grasping Tissue And Cutting Interproximally. For An Easy Identification, Only One Ring Is Gold Coated.



1514-11SC
11.5cm
Curved



1514-12SC 11cm
La Grange Curved
Super Cut Sharp/Sharp



1514-14SC 13cm
Goldman-Fox Straight
Super Cut



1514-16SC 13cm
Goldman-Fox Double Curved
Super Cut



1514-21-BK
11cm
Curved



1514-22-BK 11cm
La Grange Curved
Super Cut Sharp/Sharp



1514-25-BK
13cm
Curved



1514-26-BK 13cm
Goldman-Fox Double Curved

1514-20-BK 11cm
Iris Scissor Straight
Super Cut Sharp/Sharp

1514-24-BK 13cm
Goldman-Fox Straight



1515-10
10cm
Curved

1515-10 10cm
Castroviejo Straight



1515-11 11cm
Angular

1515-13 11cm
Noyes Angular



1515-14 14cm
1515-16 16cm
1515-18 18cm
Castroviejo Straight



1515-15 14cm
1515-17 16cm
1515-19 18cm
Castroviejo Curved

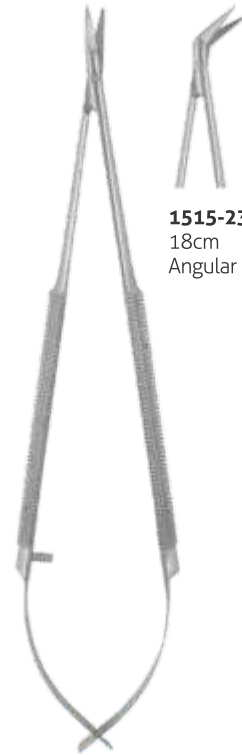

1515-22 18cm
Castroviejo Straight



1515-23
18cm
Angular



1515-50 16cm Straight
1515-51 16cm Curved
1515-52 18cm Straight
1515-53 18cm Curved
Castroviejo



1515-25 14cm
1515-26 16cm
1515-27 18cm
Curved

1515-24 14cm
1515-26 16cm
1515-28 18cm
Castroviejo Straight



1515-31T 14cm
1515-33T 16cm
1515-35T 18cm
Curved

1515-30T 14cm
1515-32T 16cm
1515-34T 18cm
Castroviejo Straight
TC Blades



1515-37SC 14cm
1515-39SC 16cm
1515-41SC 18cm
Castroviejo Curved

1515-36SC 14cm
1515-38SC 16cm
1515-40SC 18cm
Castroviejo Straight
Super Cut / Serrated Blade



1515-42TM 14cm
1515-44TM 16cm
1515-46TM 18cm
Castroviejo Angular
Titanium

Needle Holders, Also Known As A Needle Drivers. They Are Used In Wound Closure, Ligation, Reanastomosis and Other Surgical Procedures Which Require Suturing. The Needle Is Usually Held In Position By A Clamp Mechanism, Which Allows The Operator To Manipulate The Needle Through Various Tissues. The Jaws Are Generally Textured And Short In Comparison To The Shank To Retain A Solid Grasp On The Needle.

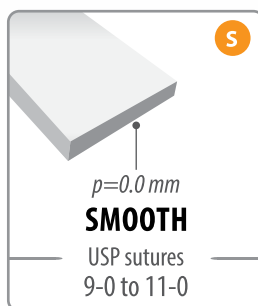
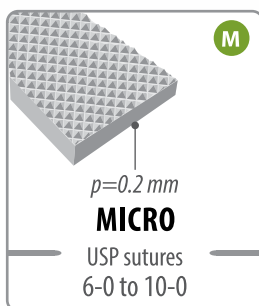
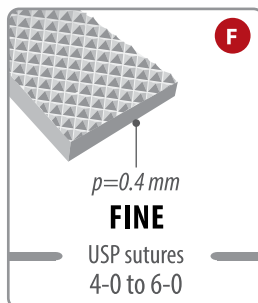
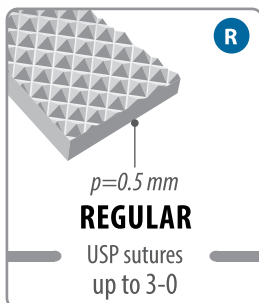



1516-10 15cm
1516-12 18.5cm
1516-14 20cm
1516-16 23.5cm
 Mayo-Hegar
 ☞ 2-0, 3-0, 4-0



1516-20 10cm
1516-22 15cm
1516-24 20cm
 Crile-Wood
 ☞ 3-0, 4-0, 5-0, 6-0



1516-26 18cm
 Adson
 ☞ 1-0, 2-0, 3-0, 4-0



1516-28 13cm
 Halsey
 ☞ 3-0, 4-0, 5-0, 6-0

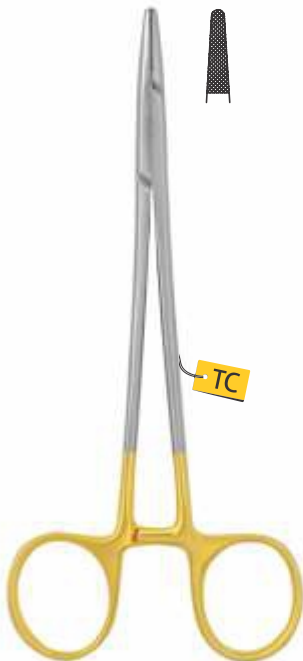

1516-10T 15cm
1516-12T 18.5cm
1516-14T 20cm
1516-16T 23.5cm
 Mayo-Hegar
 ☞ 2-0, 3-0, 4-0



1516-20T 10cm
1516-22T 15cm
1516-24T 20cm
 Crile-Wood
 ☞ 3-0, 4-0, 5-0, 6-0

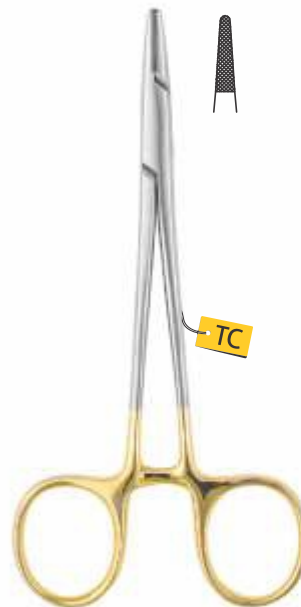

1516-28T 13cm
 Halsey
 ☞ 3-0, 4-0, 5-0, 6-0

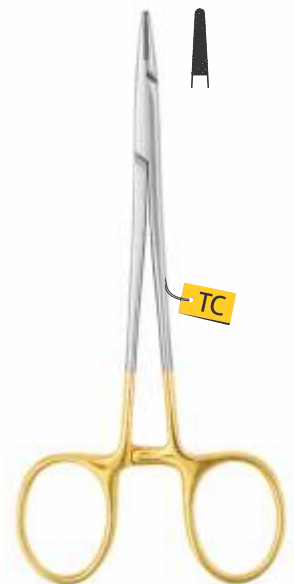

1516-30T 12.5cm
 Derf
 ☞ 3-0, 4-0, 5-0

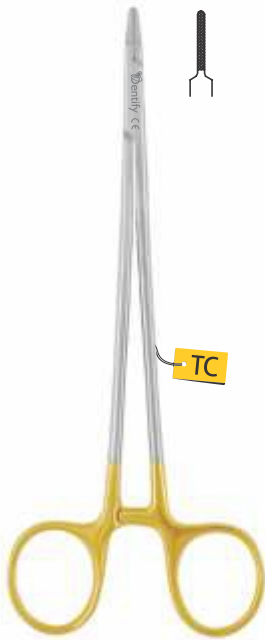

1516-32T 13.5cm
1516-34T 15cm
1516-36 T 17.5cm
 Ryder
 ☞ 3-0, 4-0, 5-0, 6-0



1516-38T 15cm
 Swedish Pattern
 ☞ 5-0, 6-0, 7-0, 8-0



1516-40T 14.5cm
 Olsen-Hegar
 ☞ 2-0, 3-0, 4-0, 5-0

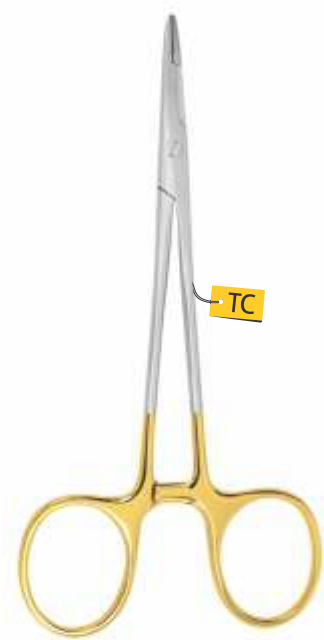

1516-42T
 Delicate Olsen Hegar
 Needle Holder with Scissor
 12cm

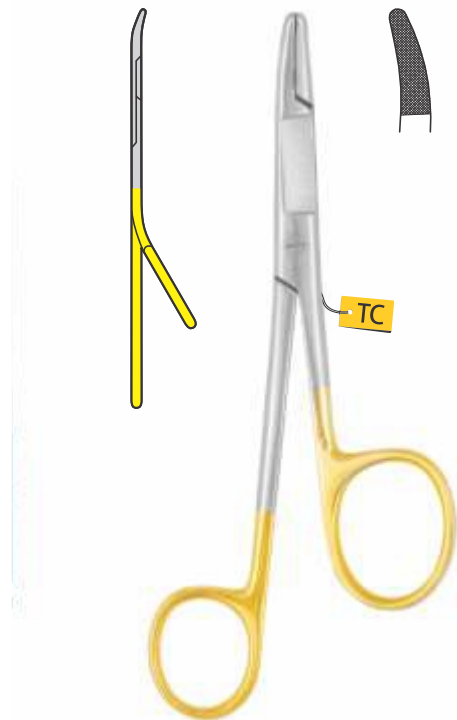

1516-44T 16cm
 Gillies
 ☞ 2-0, 3-0, 4-0, 5-0



1516-98TM
 Titanium Needle Holder
 14.5cm



1516-61T 14cm
1516-63T 16cm
1516-65T 18cm
Castroviejo Curved

TC



1516-67T 14cm
1516-69T 16cm
1516-71T 18cm
Castroviejo Curved

TC

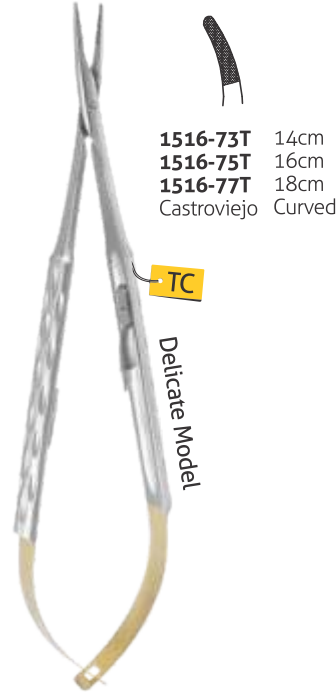

1516-73T 14cm
1516-75T 16cm
1516-77T 18cm
Castroviejo Curved

TC

Delicate Model

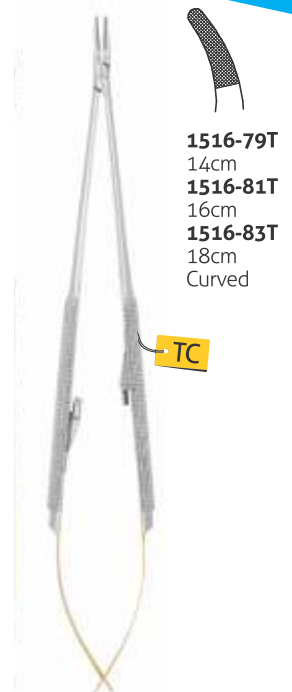

1516-79T 14cm
1516-81T 16cm
1516-83T 18cm
Curved

TC

1516-60T 14cm
1516-62T 16cm
1516-64T 18cm
Castroviejo Straight
☪ 4-0, 5-0, 6-0

1516-66T 14cm
1516-68T 16cm
1516-70T 18cm
Castroviejo Straight
☪ 4-0, 5-0, 6-0

1516-72T 14cm
1516-74T 16cm
1516-76T 18cm
Castroviejo Straight
☪ 4-0, 5-0, 6-0

1516-78T 14cm
1516-80T 16cm
1516-82T 18cm
Castroviejo Straight
☪ 4-0, 5-0, 6-0



1516-52T
Castroviejo
16cm
Straight

TC

1516-50T
Castroviejo
16cm
Curved

Titanium Needle Holders



Ti



Ti



Ti



Ti

1516-90TM 16cm
1516-92TM 18cm
Titanium Micro
Needle Holder Straight

1516-91TM 16cm
1516-93TM 18cm
Titanium Micro
Needle Holder Curved

1516-94TM 16cm
1516-96TM 18cm
Titanium Micro
Needle Holder Straight

1516-95TM 16cm
1516-97TM 18cm
Titanium Micro
Needle Holder Curved

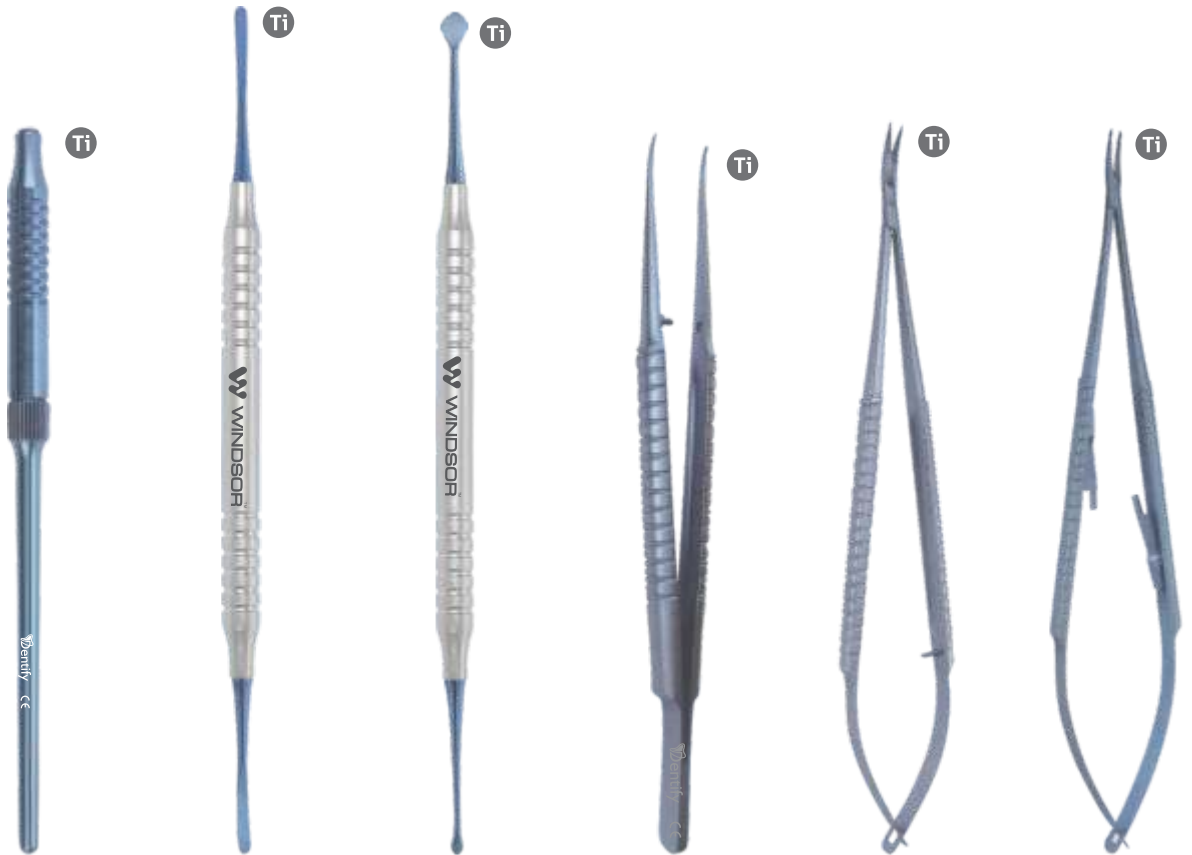

1511-36TM
Handle For
Micro Blades
13.5cm

1424-15TM
Periosteal Hp3
Titanium

1424-20TM
Periosteal Molt
Titanium

1519-61TM
Micro Tweezer
Titanium
15cm

1515-35TM
Micro Scissors
Titanium
18cm

1516-101-TM
Micro Needle
Holder Titanium
18cm

1515-01KT
Micro Periodontal Surgery Kit (6 Pieces)

Content

- 1519-61TM** Micro Tweezer Titanium Curved
- 1515-35TM** Micro Scissor Titanium Curved
- 1516-101TM** Micro Needle Holder Titanium Curved
- 1511-36TM** Handle For Micro Blades
- 1424-15TM** Periosteal Hp3 Titanium
- 1424-20TM** Periosteal Molt Titanium
- 1911-10-B** Instruments Cassette

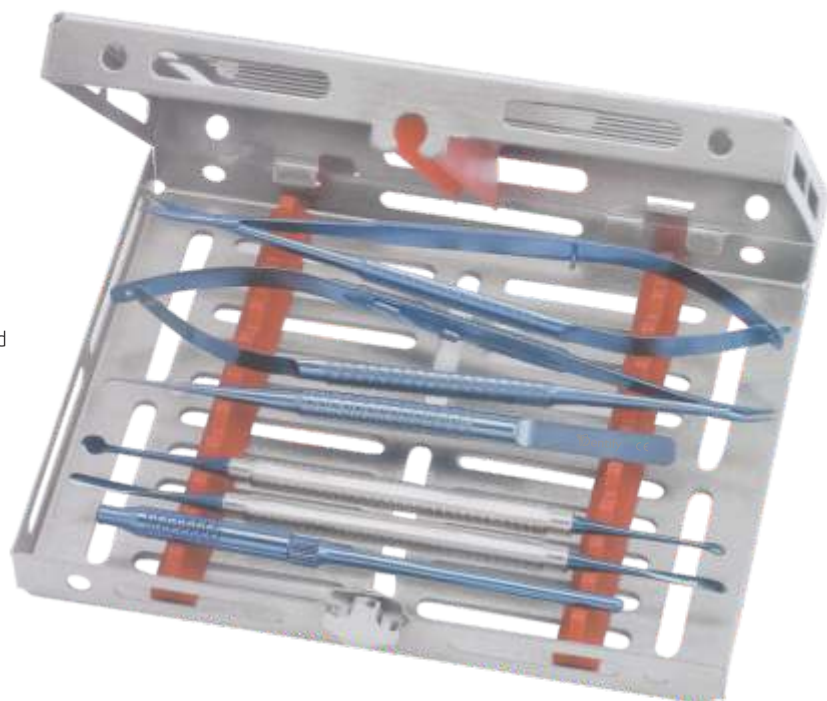



1769-39T 14cm
Mathieu
☺ 2-0, 3-0, 4-0



1769-39 14cm
Mathieu
☺ 2-0, 3-0, 4-0

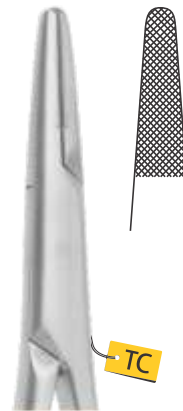

1769-45T 16cm
Mathieu
☺ 2-0, 3-0, 4-0

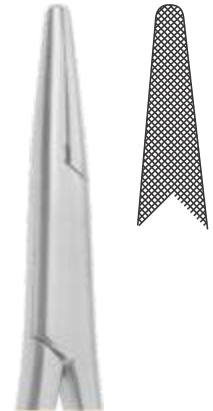

1769-45 16cm
Mathieu
☺ 2-0, 3-0, 4-0

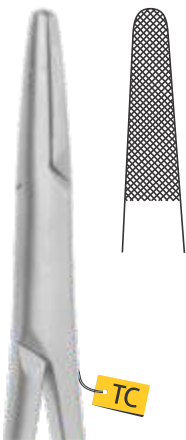

1769-68T 16cm
Mathieu
☺ 2-0, 3-0, 4-0



1769-68 16cm
Mathieu
☺ 2-0, 3-0, 4-0



1769-60T 12cm
Boynton
☺ 4-0, 5-0, 6-0

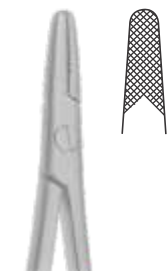

1769-60 12cm
Boynton
☺ 4-0, 5-0, 6-0

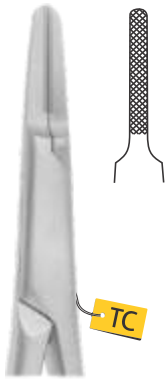
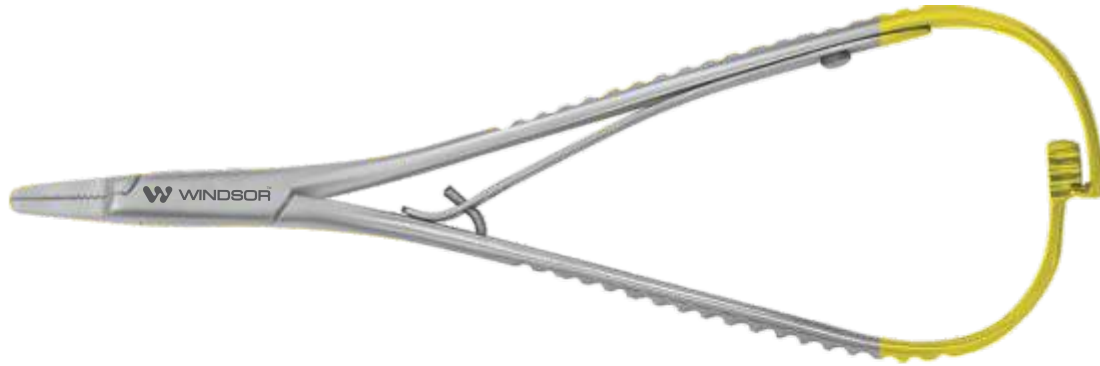

1769-72T 14cm
Mathieu

☪ 2-0, 3-0, 4-0



1769-72 14cm
Mathieu

☪ 2-0, 3-0, 4-0



1769-74T 16cm
Mathieu

☪ 2-0, 3-0, 4-0



1769-74 16cm
Mathieu

☪ 2-0, 3-0, 4-0

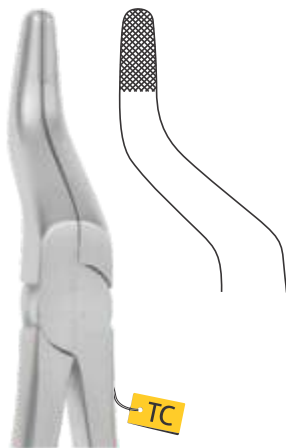

1769-76T 20cm
Eiselsberg-Mathieu

☪ 2-0, 3-0, 4-0

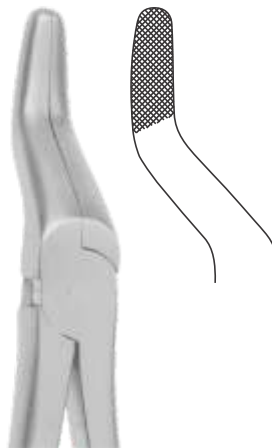

1769-76 20cm
Eiselsberg-Mathieu

☪ 2-0, 3-0, 4-0



Suture Scissors



1512-18
Spencer
9cm

1512-19
Spencer
13cm

1512-20
Spencer
11.5cm

Suture Tweezers



1519-80
15.5cm

1519-85
Squared tip
15.5cm

1519-90
Round tip
15.5cm

1512-01KT
Suture Removal Kit (7 Pieces)

- Content:-
- 1114-10** Perry Tweezer
 - 1114-13** Meriam Tweezer
 - 1512-18** Spencer Scissor
 - 1512-19** Spencer Scissor
 - 1512-20** Spencer Scissor
 - HM-14** Mirror Handle with #5 Mirror
 - 1111-20** Double Explorer
 - 1911-10-B** Instruments Cassette



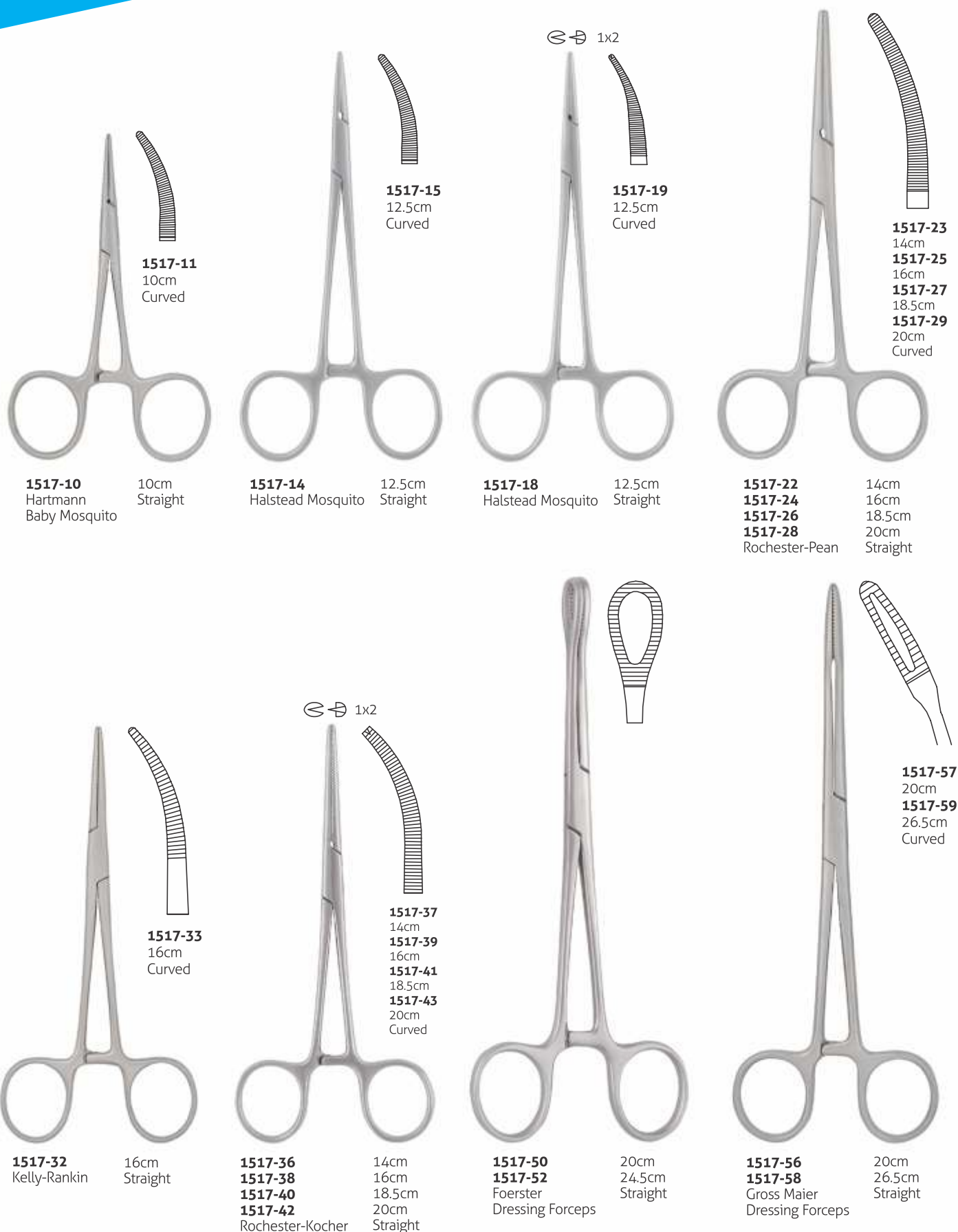



1518-10 14cm
Backhaus



1518-12 13.5cm
Backhaus

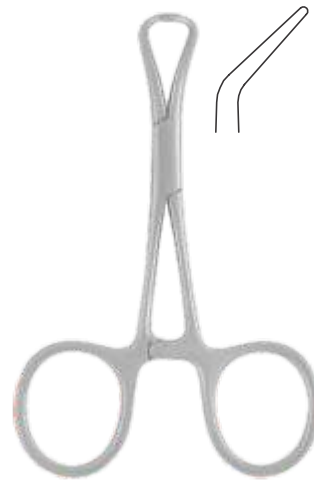

1518-14 9cm
Backhaus



1518-17
Jones
9cm



1518-18 9.5cm
1518-20 13.5cm
Loarna



1518-22 4:5
1518-24 5:6
Allis 15.5cm



1518-26 4:5
1518-28 5:6
Allis 19cm



1518-31
Spare part

1518-30 17cm
Young
Tongue Forceps



1519-10 1.2mm
Adson 12cm



1519-12 0.7mm
Micro Adson 12cm



1519-14 1.2mm
Adson 12cm
1x2



1519-16 0.7mm
Micro Adson 12cm
1x2



1519-18 1.2mm
Adson 12cm
1x2
with Cross Serration



1519-20T 1.5mm
TC Adson 12cm



1519-22
Adson-Brown
1.5mm
12cm



1519-22T
Adson-Brown
1.5mm
12cm



1519-24
Micro Adson
0.9mm
15cm



1519-30 11.5cm
1519-32 13cm
1519-34 14.5cm
1519-36 15cm
1519-38 16cm
Standard



1519-31 11.5cm
1519-33 13cm
1519-35 14.5cm
1519-37 15cm
1519-39 16cm
Tissue Forceps



1519-40
Gillies
1.5mm
15cm



1519-41
Gillies
1.5mm
15cm



Atraumatic Tissue Tweezer,
For Gripping Membrane &
Tissue Safely. The Special
Serration Prevents The
Perforation Of The Tissue.



1519-50
De Bakey
1.5mm
15.5cm



1519-50T
De Bakey
1.5mm
15.5cm



1519-51
De Bakey
1.5mm
15.5cm



1519-54
Diamond
Coated
18cm

1519-55
Curved
18cm



1519-56
Round 1x2
0.9mm
18cm

1519-57
Curved
18cm



1519-59
Curved
18cm

1519-58
Round
18cm



1519-62
Cushing
1.5mm
17.5cm



1519-62T
Cushing
1.5mm
17.5cm



1519-64
Russian
6mm
15cm



1519-66T
Potts Smith
1.5mm
18cm



1519-68
Gerald
1mm
17.5cm



1519-69
Curved
17.5cm



1519-71
Curved
17.5cm

1519-70
Gerald 1x2
1.5mm
17.5cm

› EU: European Thread
› AM: American Thread

Intraligamental Syringes



- **1520-10BL** ml 1.8 EU
- **1520-12BL** ml 1.8 AM
- Aluminium - Blue

Available colors

- **1520-10GR** ml 1.8 EU
- **1520-12GR** ml 1.8 AM
- Aluminium - Green

- **1520-10OR** ml 1.8 EU
- **1520-12OR** ml 1.8 AM
- Aluminium - Orange

- **1520-10DA** ml 1.8 EU
- **1520-12DA** ml 1.8 AM
- Aluminium - Dark

- **1520-10SL** ml 1.8 EU
- **1520-12SL** ml 1.8 AM
- Aluminium - Silver

Advantages Of Intraligamental Anesthesia:

- Automatic Limitation Of The Power Pressure.
- No Numbness Of The Tongue, Lips Or Cheek.
- Anesthetizing Of A Single Tooth.
- Supports Regional Block Anesthesia.
- Simultaneous Treatment Of Teeth In Different Quadrants.
- Lower Emotional Impact On Patient.
- Eliminates The Risk Of Haematoma.

Aspirating Syringes - Stainless Steel



Stainless Steel, Autoclavable
Silicone Handle
1520-34-BL ml 1.8 EU/AM
1520-36-BL ml 2.2 EU/AM



1520-17 ml 1.8 EU
1520-19 ml 2.2 AM
0.07 ml/click



1520-20 ml 1.8 EU/AM
1520-22 ml 2.2 EU/AM



1520-21 ml 1.8 EU/AM
1520-23 ml 2.2 EU/AM



1520-68 ml 1.8
1520-69 ml 2.2



1520-78 ml 1.8
1520-79 ml 2.2



EU European - METRIC thread



AM American - INCH thread



1520-54 ml 1.8
1520-55 ml 2.2

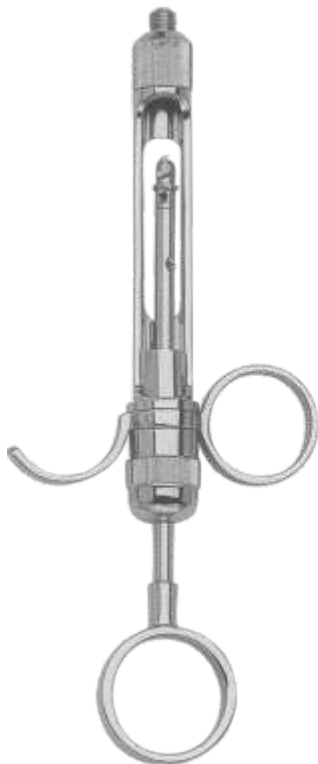

1520-38 ml 1.8 EU/AM
1520-40 ml 2.2 EU/AM

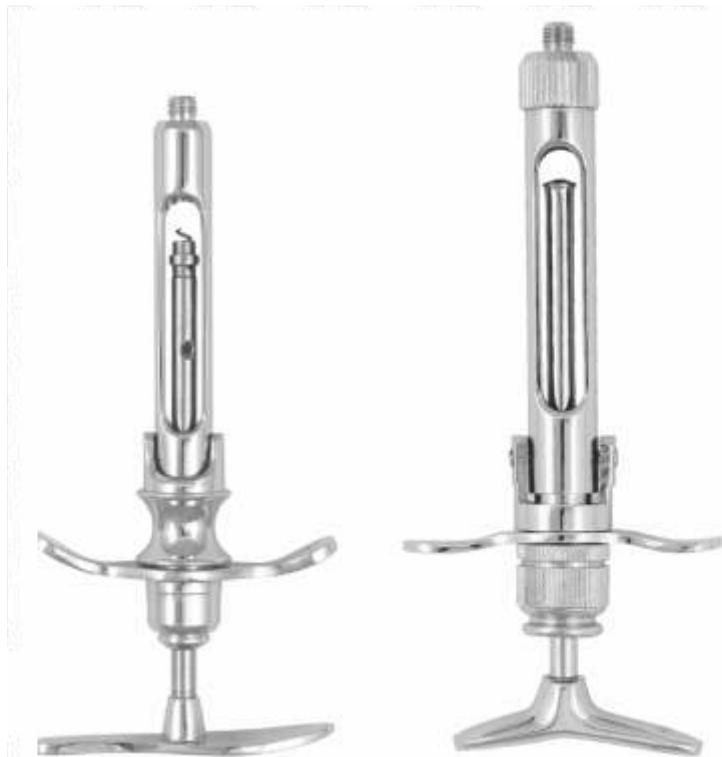

Folding Type-Not Aspirating
1520-46 ml 1.8 EU/AM
1520-48 ml 2.2 EU/AM

Folding Type
1520-50 ml 1.8 EU/AM
1520-52 ml 2.2 EU/AM



1520-56
ml 1.8 EU/AM



1521-10 30x10mm
Langenbeck 21cm



1521-12 30x16mm
1521-14 40x11mm
1521-16 50x11mm
Langenbeck 21cm



1521-17 35x11mm
1521-18 40x11mm
1521-20 55x11mm
Kocher 21.5cm



1521-21 31x10mm
1521-22 42x11mm
1521-24 60x12mm
Obwegeser 22cm



1521-26 15x17mm
1521-28 20x22mm
Middeldorpf 22cm

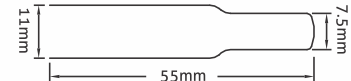
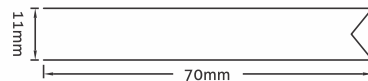

1521-30 35x11mm
1521-32 70x11mm
Ramus-Haken 22cm
Obwegeser



1521-34 55x11mm
Muller 22cm

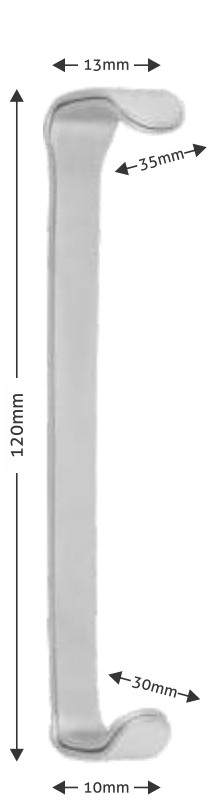

1522-20
Farabeuf
Set of 2

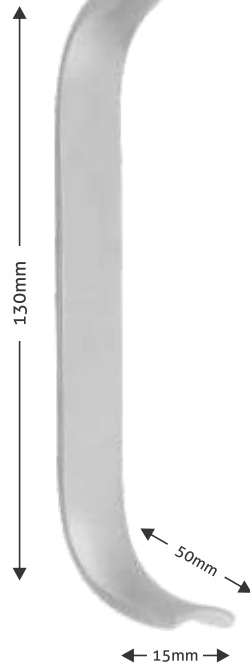

1522-42
Archetto

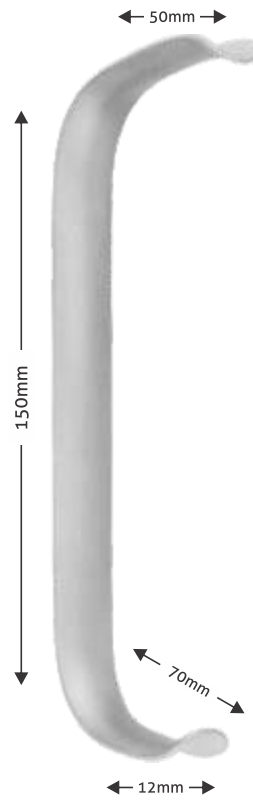

1522-44
Archetto



1522-46
Retractor
11.5cm



1522-48
Wieder
14 cm

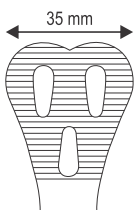

1522-49
Wieder
15 cm



Wieder
Tongue Sepsor
(110 x 100 mm)



1522-50 9cm
1522-51 14cm
Austin
Tissue Retractors



1522-10
Senn-Miller
16cm



1522-12
Blunt
16.5cm
1522-13
Sharp
16.5cm



1522-14
Desmarres
15x10mm
16.5cm



1522-16
Hook
18cm



1522-18
Minnesota University
14cm



1522-22
Bruenings
Tongue Depressor
19cm

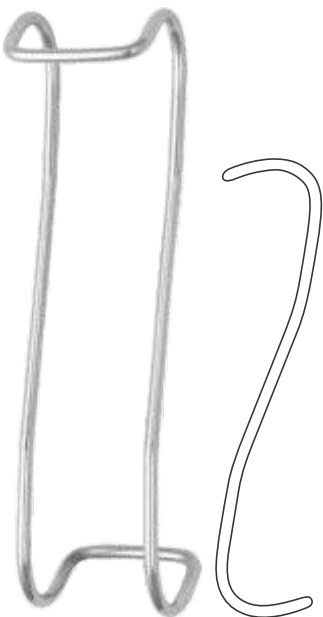

1522-24
Sternberg
14cm



1522-28
Sternberg
16cm



1522-30
Vestibulum
15cm

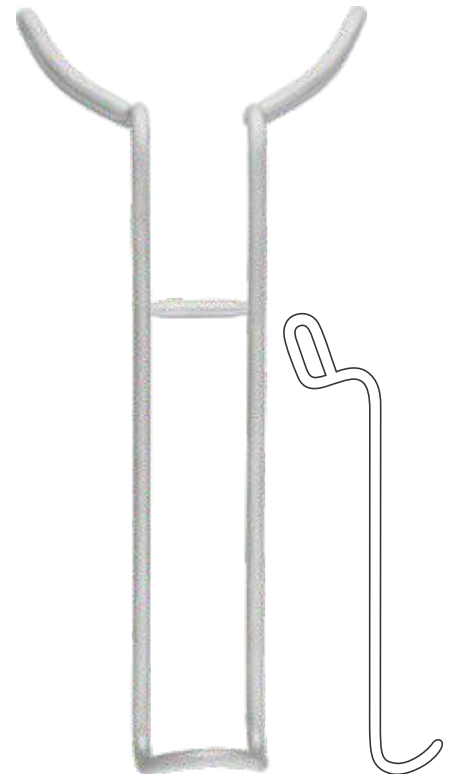

1522-32
Universal Retractor
17cm



Malleable Retractors

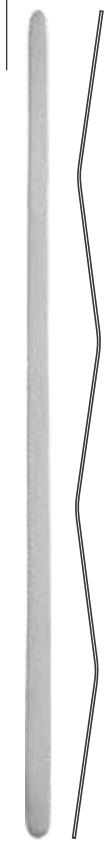

1522-60
24cm



1522-61
20cm

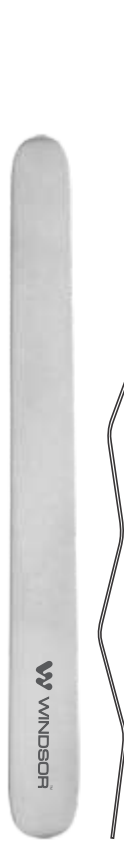

1522-62
20.5cm



1522-63
Lame De Tessier
21.5cm



1522-66
Obwegeser
15cm
Chin Retractor



1424-42
Seldin 23 19.5cm



1424-50
Henahan
17cm



1527-10
Mouth Gag (Pedo Size)
9cm



1527-12
Mouth Gag (Child Size)
11cm



1527-14
Mouth Gag (Adult Size)
14cm



1527-16
Weitlaner Self-Retaining
Blunt
16.5cm



1527-18 16cm
1527-20 19cm
Roser-König



Silicon Mouth Props Autoclavable
with Chain



1527-30
Mouth Prop Small



1527-31
Mouth Prop Medium



1527-32
Mouth Prop Large



Used For Curettage, Cyst Removal and Debridement Of Tooth Socket



3.5mm



1523-30
Molt 2

7mm



1523-32
Molt 4



Handle



1523-34
Molt 5L



1523-35
Molt 5R

For Curettage and Cyst Removal



3.5mm

3.5mm

1523-40
Miller 8



3.4mm

2.8mm

1523-42
Miller 9



3.5mm

7mm

1523-50
Molt 2 1/4



Straight Cut Files Are Used For Final Smoothing Of Bone



Cross Cut Files Increase Efficiency By Cutting In All Directions



1524-10
BF45
Miller



1524-12
BF1W
Wahl



1524-14
BF2W
Wahl



1524-16
BF1X
Miller



1524-18
BF2X
Miller



1524-20
BF3X
Miller



1524-22
BF21
Miller



1525-10-BL
Hemingway Fig. 4

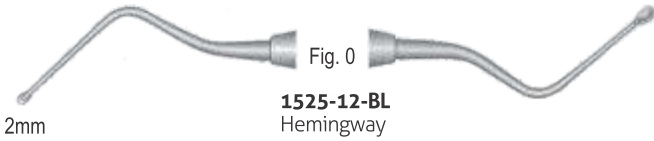

1525-12-BL
Hemingway

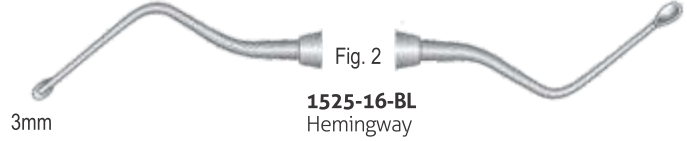

1525-16-BL
Hemingway

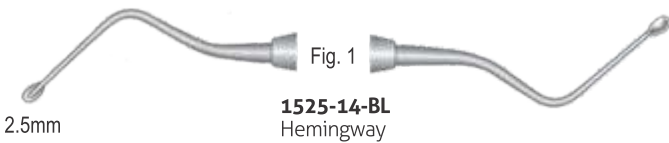

1525-14-BL
Hemingway

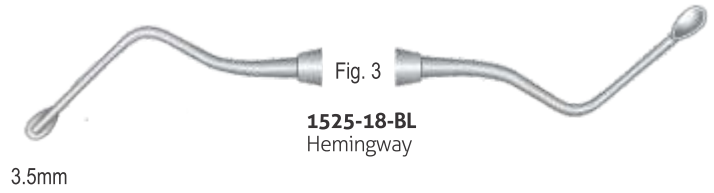

1525-18-BL
Hemingway

	Fig. 00/0 1525-22	Fig. 0/1 1525-24	Fig. 1/2 1525-26		Fig. 0000 1525-30	Fig. 000 1525-32	Fig. 00 1525-34	
			Fig. 0 1525-36	Fig. 1 1525-38	Fig. 2 1525-40			
			Fig. 3 1525-42					

Williger
15cm

Volkmann
17cm



1526-10
Blumenthal
15.5cm



1526-12
Blumenthal 45°
15cm



1526-14
Blumenthal 90°
14cm



1526-16
Micro Luer
15cm



1526-18
Luer
15cm



1526-20
Lempert Delicate
16cm



1526-22
Friedmann
14cm



1526-24
Micro Friedmann
14.5cm



1526-26
Micro Friedmann 90°
14.5cm

Double Action Hinged



1526-28
18M Double
Action Side-Cutting
17cm



1526-30
Beyer
Double Action
18cm



1526-32
Boehler
Double Action
16cm