



**1611-11**  
17cm  
Straight

- Black    ø 2.7mm
- Red      ø 3.2mm
- Blue     ø 3.7mm
- Orange   ø 4.2mm
- Yellow   ø 5mm



**1611-11CX** ø 2.7mm  
**1611-12CX** ø 3.2mm  
**1611-13CX** ø 3.7mm  
**1611-14CX** ø 4.2mm  
**1611-15CX** ø 5mm  
**Convex**



**1611-11CV** ø 2.7mm  
**1611-12CV** ø 3.2mm  
**1611-13CV** ø 3.7mm  
**1611-14CV** ø 4.2mm  
**1611-15CV** ø 5mm  
**Concave**



**1611-11PT** ø 2.7mm  
**1611-12PT** ø 3.2mm  
**1611-13PT** ø 3.7mm  
**1611-14PT** ø 4.2mm  
**1611-15PT** ø 5mm  
**Pointed**



**1611-16**  
17cm  
Bayonet



**1611-16CX** ø 2.7mm  
**1611-17CX** ø 3.2mm  
**1611-18CX** ø 3.7mm  
**1611-19CX** ø 4.2mm  
**1611-20CX** ø 5mm  
**Convex**



**1611-16CV** ø 2.7mm  
**1611-17CV** ø 3.2mm  
**1611-18CV** ø 3.7mm  
**1611-19CV** ø 4.2mm  
**1611-20CV** ø 5mm  
**Concave**



**1611-16PT** ø 2.7mm  
**1611-17PT** ø 3.2mm  
**1611-18PT** ø 3.7mm  
**1611-19PT** ø 4.2mm  
**1611-20PT** ø 5mm  
**Pointed**





**1611-21**  
17cm  
Straight

- Red     $\varnothing$  2.7mm
- Blue    $\varnothing$  3.2mm
- Yellow  $\varnothing$  3.7mm
- Orange  $\varnothing$  4.2mm
- Grey     $\varnothing$  5mm



**1611-21CX**  $\varnothing$  2.7mm  
**1611-22CX**  $\varnothing$  3.2mm  
**1611-23CX**  $\varnothing$  3.7mm  
**1611-24CX**  $\varnothing$  4.2mm  
**1611-25CX**  $\varnothing$  5mm  
**Convex**



**1611-21CV**  $\varnothing$  2.7mm  
**1611-22CV**  $\varnothing$  3.2mm  
**1611-23CV**  $\varnothing$  3.7mm  
**1611-24CV**  $\varnothing$  4.2mm  
**1611-25CV**  $\varnothing$  5mm  
**Concave**



**1611-21PT**  $\varnothing$  2.7mm  
**1611-22PT**  $\varnothing$  3.2mm  
**1611-23PT**  $\varnothing$  3.7mm  
**1611-24PT**  $\varnothing$  4.2mm  
**1611-25PT**  $\varnothing$  5mm  
**Pointed**



**1611-26**  
17cm  
Bayonet



**1611-26CX**  $\varnothing$  2.7mm  
**1611-27CX**  $\varnothing$  3.2mm  
**1611-28CX**  $\varnothing$  3.7mm  
**1611-29CX**  $\varnothing$  4.2mm  
**1611-30CX**  $\varnothing$  5mm  
**Convex**

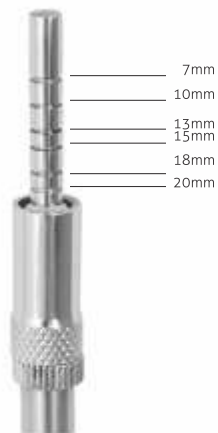

**1611-26CV**  $\varnothing$  2.7mm  
**1611-27CV**  $\varnothing$  3.2mm  
**1611-28CV**  $\varnothing$  3.7mm  
**1611-29CV**  $\varnothing$  4.2mm  
**1611-30CV**  $\varnothing$  5mm  
**Concave**



**1611-26PT**  $\varnothing$  2.7mm  
**1611-27PT**  $\varnothing$  3.2mm  
**1611-28PT**  $\varnothing$  3.7mm  
**1611-29PT**  $\varnothing$  4.2mm  
**1611-30PT**  $\varnothing$  5mm  
**Pointed**



**1611-01KT**  
Sinus Elevation Internal Kit (5 Pieces)  
Osteotomes Bayonet, Concave

**Contents:-**  
1611-26CV ø 2.7mm  
1611-27CV ø 3.2mm  
1611-28CV ø 3.7mm  
1611-29CV ø 4.2mm  
1611-30CV ø 5mm  
1911-05-B 5 Instruments Cassette



**1611-02KT**  
Sinus Elevation Internal Kit (5 Pieces)  
Osteotomes Straight, Concave

**Contents:-**  
1611-21CV ø 2.7mm  
1611-22CV ø 3.2mm  
1611-23CV ø 3.7mm  
1611-24CV ø 4.2mm  
1611-25CV ø 5mm  
1911-05-B 5 Instruments Cassette



**1611-03KT**  
Sinus Elevation Internal Kit (11 Pieces)

<b>Contents:-</b>			
1611-26CV ø 2.7mm	1611-21CV ø 2.7mm		
1611-27CV ø 3.2mm	1611-22CV ø 3.2mm		
1611-28CV ø 3.7mm	1611-23CV ø 3.7mm		
1611-29CV ø 4.2mm	1611-24CV ø 4.2mm		
1611-30CV ø 5mm	1611-25CV ø 5mm		
1613-15 Hammer Mead	1911-20-B 20 Instruments Cassette		



**1611-04KT**  
Sinus Elevation Internal Kit (10 Pieces)

<b>Contents:-</b>			
1611-26CV ø 2.7mm	1611-21CV ø 2.7mm		
1611-27CV ø 3.2mm	1611-22CV ø 3.2mm		
1611-28CV ø 3.7mm	1611-23CV ø 3.7mm		
1611-29CV ø 4.2mm	1611-24CV ø 4.2mm		
1611-30CV ø 5mm	1611-25CV ø 5mm		
	1911-10-B 10 Instruments Cassette		



**1612-10**  
N.10  
1.5/1.5mm  
17cm



**1612-11**  
N.11  
3/3mm  
17cm



**1612-12**  
N.12  
3.5/3.5mm  
17cm



**1612-13**  
N.13  
3/3mm  
17cm



**1612-14**  
N.14  
2.5/2.5mm  
17cm



**1612-15**  
N.15  
4/4mm  
17cm



**1612-16**  
N.16  
5/5mm  
17cm

**1612-01KT**  
Sinus Lift Kit (7 Pieces)

- Contents:-**
- 1612-10 Sinus Lift N. 10
  - 1612-11 Sinus Lift N. 11
  - 1612-12 Sinus Lift N. 12
  - 1612-13 Sinus Lift N. 13
  - 1612-14 Sinus Lift N. 14
  - 1612-15 Sinus Lift N. 15
  - 1612-16 Sinus Lift N. 16
  - 1911-07-C 7 Instruments Cassette

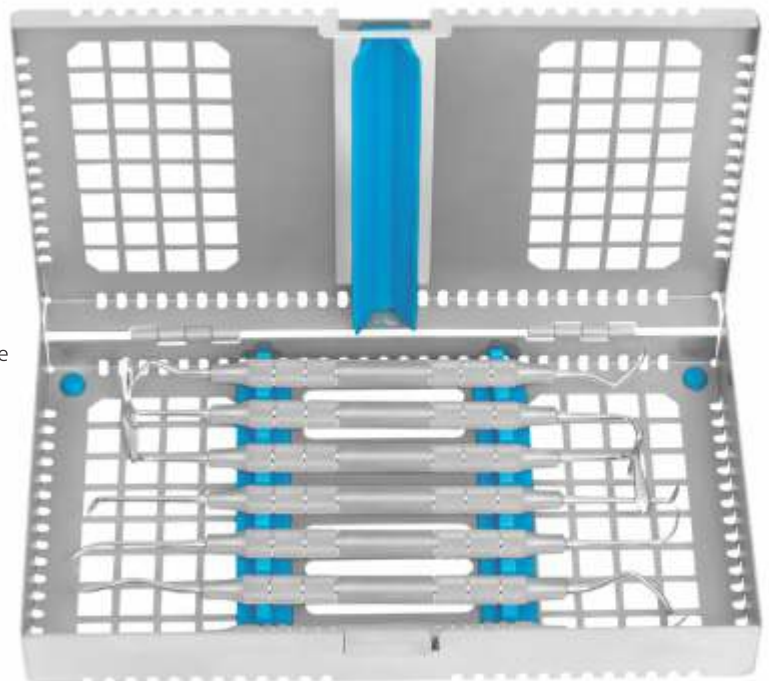
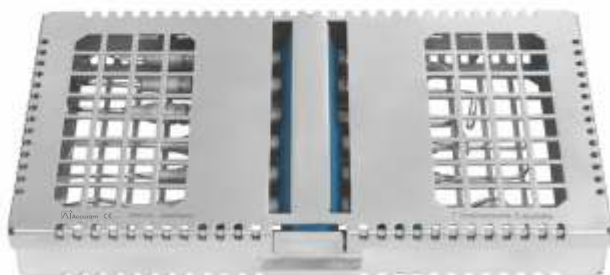





1612-50 Sinus Elevation Instrument # 1

1612-52 Sinus Elevation Instrument # 2

1612-54 Sinus Elevation Instrument # 3

1612-56 Sinus Elevation Instrument # 4



1612-76  
Drill # 1

1612-74  
Drill # 2

1612-72  
Drill # 3

1612-66  
Drill # 4

1612-64  
Drill # 5

1612-62  
Drill # 6

1612-82  
Stopper 02

1612-84  
Stopper 04

1612-86  
Stopper 06

1612-88  
Stopper 08



**1612-02KT**  
Advanced Sinus Kit (14 Pieces)

- Contents:-**
- 1612-50 Sinus Elevation Instrument # 1
  - 1612-52 Sinus Elevation Instrument # 2
  - 1612-54 Sinus Elevation Instrument # 3
  - 1612-56 Sinus Elevation Instrument # 4
  - 1612-76 Drill # 1
  - 1612-74 Drill # 2
  - 1612-72 Drill # 3
  - 1612-66 Drill # 4
  - 1612-64 Drill # 5
  - 1612-62 Drill # 6
  - 1612-82 Stopper 02
  - 1612-84 Stopper 04
  - 1612-86 Stopper 06
  - 1612-88 Stopper 08



**1612-03KT**  
Lateral Approach  
Sinus Lift Drills Kit  
(06 Pieces)



**1612-04KT**  
Lateral Approach Sinus Lift Kit  
Diamond Coated  
(04 Pieces)

Sizes:  
Ø6mm, Ø8mm

### Implants Kits



**1624-01KT**  
Universal Dental Implant Kit  
(50 Pieces)



**1624-02KT**  
Full Surgical Kit  
(28 Pieces)



36mm



**1613-11**  
Mead Interchangeable  
Teflon Inserts  
17cm  
170 g  
ø 20mm

45mm

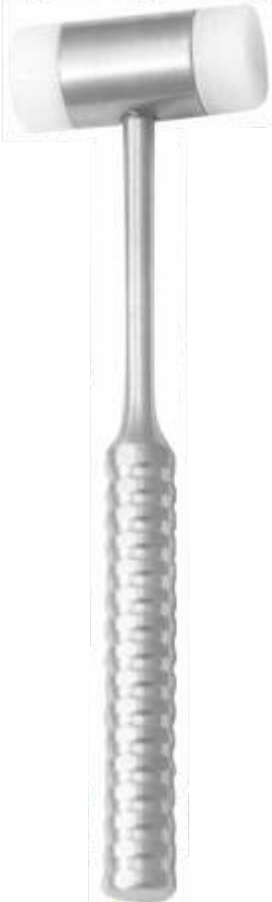

**1613-12**  
Mead Interchangeable  
Teflon Inserts  
17cm  
170 g  
ø 20mm

60mm



**1613-13**  
Mead Interchangeable  
Teflon Inserts  
18.5cm  
200 g  
ø 25mm

55mm



**1613-15**  
Mead Interchangeable  
Teflon Inserts  
18cm  
320 g  
ø 25mm

35mm



**1613-17**  
Partsch Lead Filled  
19cm  
195 g  
ø 21mm

Bone Scraper Is An Ideal Tool For Quick and Easy Harvesting Autologous Bone Material. It Is Used For Scraping, Collection And Transplantation Of Autologous Bone. Saws, And Trepine Bone Filters Are No Longer Necessary. During Scraping, The Bone Is Collected In A Chamber, And Simultaneously Mixed With The Blood. The Bone Material Can Be Implanted Directly. Often The Collected Bone Material Is Mixed With Bone Grafting And Bone Graft Material To Use Their Osteoinductive Effect.

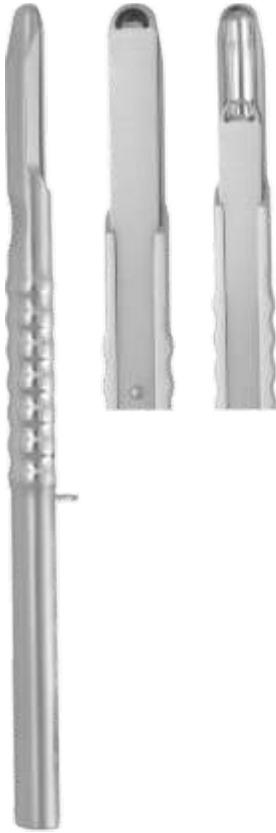

**1614-11**  
Bone Scraper  
Straight



**1614-11BL**  
Replacement Blade



**1614-12**  
Bone Scraper  
Curved



**1614-12BL**  
Replacement Blade

4.4mm



**1614-14** 2.5mm  
**1614-15** 3.5mm

**1614-17**  
Bone Syringe  
4.4mm

**Bone Mill & Bone Crusher**



**1614-30**  
Bone Mill



**1614-40**  
Bone Crusher



**1614-32**  
Bone Mill



**1614-42**  
Bone Mixing  
Bowl



**1614-50**  
Bone Crusher  
Forcep



**1615-01KT**  
Soft Brushing Kit  
(05 Pieces)



**1615-10-BL**  
Regular Tip



**1615-12-BL**  
Medium Tip



**1615-14-BL**  
Large Tip



**1615-16-BL**  
Angulated Left Tip



**1615-18-BL**  
Angulated Right Tip



7-10-13-15-18mm

**1616-11**  
4mm Str



7-10-13-15-18mm

**1616-12**  
4mm Curved



7-10-13-15-18mm

**1616-13**  
7.5mm Str



7-10-13-15-18mm

**1616-14**  
7.5mm Curved



**1616-21**  
Surgical Chisel  
3mm Single Cut



**1616-22**  
Surgical Chisel  
3mm Double Cut



**1616-23**  
Surgical Chisel  
6mm Single Cut

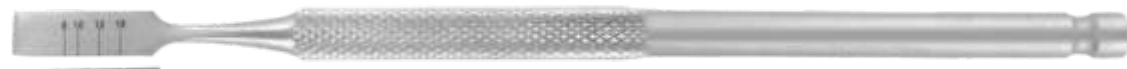

**1616-24**  
Surgical Chisel  
3mm Double Cut



**1616-25**  
Surgical Chisel  
9mm Single Cut



**1616-26**  
Surgical Chisel  
9mm Double Cut

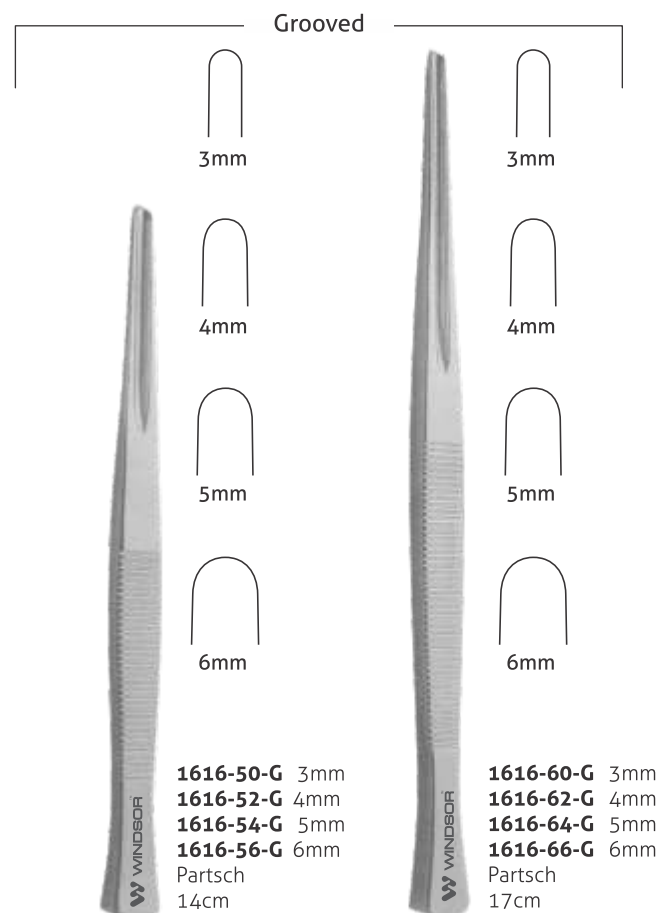
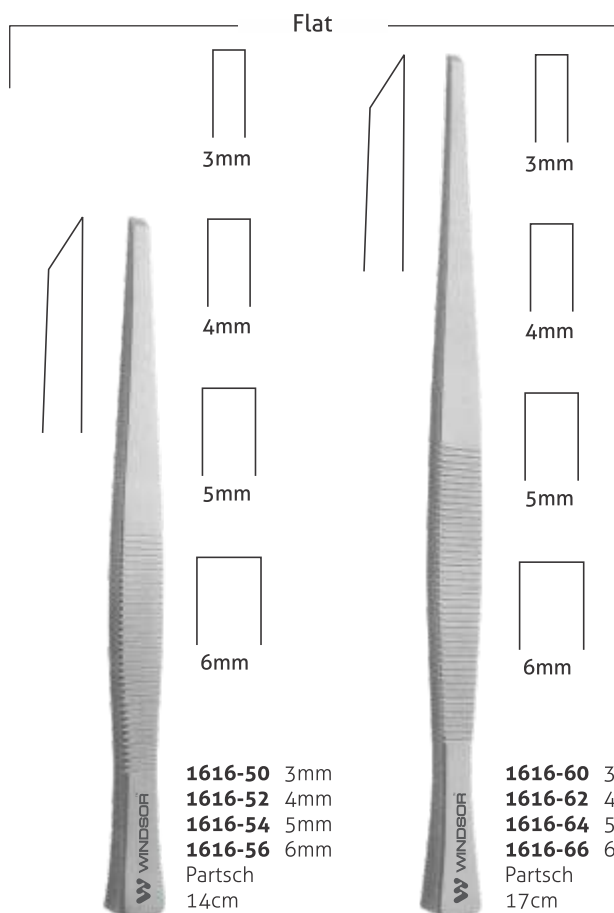
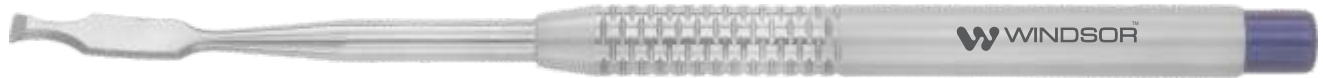



Code	ø int.	ø ext.
1617-10	2.3mm	2.9mm
1617-11	3.5mm	4.3mm
1617-12	4.1mm	4.8mm
1617-13	4.6mm	5.4mm
1617-14	5.1mm	5.9mm

Circular mucotome to remove and uncover implants in order to insert the healing screw.

Mucotome



Code	ø int.	ø ext.
1617-20	2.3mm	2.9mm
1617-21	3.5mm	4.3mm
1617-22	4.1mm	4.8mm
1617-23	4.6mm	5.4mm
1617-24	5.1mm	5.9mm

Mucotome

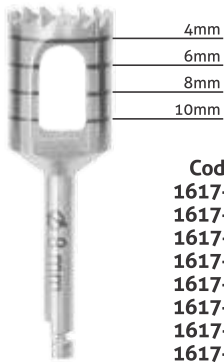

Code	ø int.	ø ext.
1617-30	3mm	3.5mm
1617-31	4mm	5mm
1617-32	5mm	6mm
1617-33	6mm	7mm
1617-34	7mm	8mm
1617-35	8mm	9mm
1617-36	9mm	10mm
1617-37	10mm	11mm

Trephine Drill Burs



1617-50	ø 4mm
1617-51	ø 5mm
1617-52	ø 6mm

Tissue Punch  
Straight



1617-55	ø 4mm
1617-56	ø 5mm
1617-57	ø 6mm

Tissue Punch  
Curved 90°



**1617-01KT**  
Trephine Drill  
Burs Kit  
(08 Pieces)

Sizes:  
Ø3mm, Ø4mm, Ø5mm, Ø6mm,  
Ø7mm, Ø8mm, Ø9mm, Ø10mm



1617-40



1617-41



1617-42



1617-43



**1617-01KT-BL**  
Trephine Drill Burs Kit  
Blue Titanium Coated  
(08 Pieces)

Sizes:  
Ø3mm, Ø4mm, Ø5mm, Ø6mm,  
Ø7mm, Ø8mm, Ø9mm, Ø10mm



1617-44



1617-45



1617-46



1617-47



**1618-10**  
Adapter



**1618-12**  
Adapter



**1618-14**  
Adapter



**1618-16**  
Adapter



**1618-18**  
Adapter



**1618-20**  
Adapter



**1618-22**  
Adapter



**1618-24**  
Spiner Key



**1618-26**  
Spiner Key



**1618-26TM**  
Spiner Key



**1618-30**  
1.42 mm  
Driver



**1618-32**  
4.0 mm  
Driver



**1618-34**  
6.35 mm  
Driver

**1619-01KT**  
Complete Kit of PRF Box with Instruments

**Contents:** All Items of this page

**1619-10**  
Membrane, Plugs & Exudate  
Perpetration Box

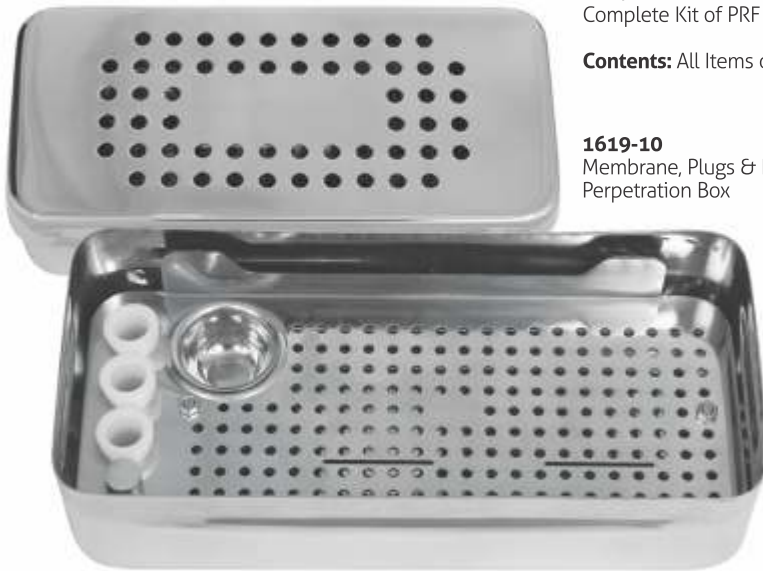

**1619-12**  
Tray & Bowl



**1619-13**  
PRF Tube Holder



**1619-14-BL**  
PRF Double Spatula



**1619-16-BL**  
PRF Scoop



**1619-18-BL**  
Bone Compactor Medium



**1619-20-BL**  
Bone Compactor Small



**1619-22**  
PRF Tweezer



**1619-24**  
PRF Tweezer



**1619-26T**  
Goldman-fox Scissor



**1620-10**  
Applicator / Compactor



**1620-12**  
Spatula



**1620-16-BL**  
Bone Graft 3.3/4mm Titanium

**1620-18-BL**  
Bone Graft 3.3/4mm Titanium Serrated



**1620-20-BL**  
Bone Graft 1/1.7mm Titanium



**1620-22-BL**  
Bone Graft 1.7/2mm Titanium



**1620-24-BL**  
Bone Graft 2.4/2.7mm Titanium



**1620-26-BL**  
Bone Graft 2.4/2.7mm Titanium



**1620-28-BL**  
Bone Graft 2.4/2.7mm Titanium



**1622-10**  
Arnohold  
Straight  
22cm



**1622-12**  
Arnohold  
Curved  
22cm



**1622-14**  
Arnohold  
Curved  
22cm



**For Placing Screws  
on Bone Blocks**



**1622-30**  
Rowe  
Left  
22.5cm



**1622-32**  
Rowe  
Right  
22.5cm

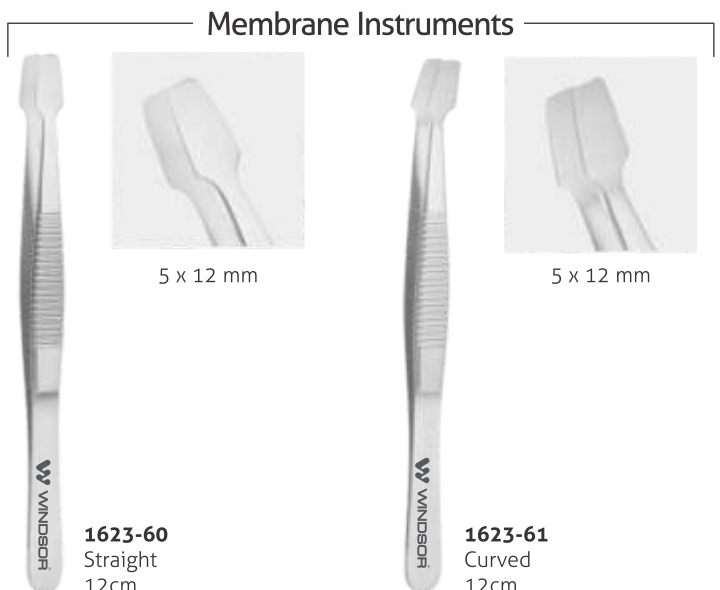
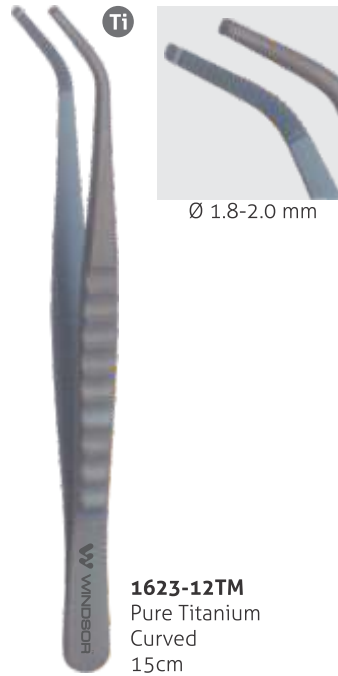
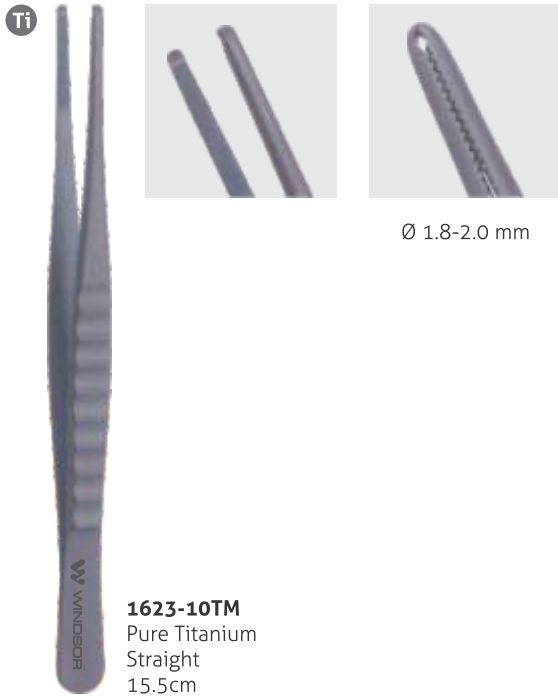



**1624-10**  
Suction Tube

**1624-12** Ø 7mm  
**1624-14** Ø 12mm  
Bone Aspirator

**1624-20** Ø 2.5mm  
**1624-21** Ø 3mm  
**1624-22** Ø 4mm  
16.5cm

**1624-25** Ø 2mm  
**1624-26** Ø 3mm  
**1624-27** Ø 4mm  
**1624-28** Ø 5mm  
Frazier  
19cm

**1624-40**  
Torque Ratchet  
Force: 0-45Ncm

**1624-50**  
Arch Turret  
Force: 0-45Ncm



**1624-03KT**  
Tissue Punch Kit (5 Pieces)

Sizes:  
Ø3.5mm, Ø4mm, Ø4.5mm, Ø5mm, Ø5.5mm



**1624-03KT-BL**  
Tissue Punch Kit Blue Titanium Coated (5 Pieces)

Sizes:  
Ø3.5mm, Ø4mm, Ø4.5mm, Ø5mm, Ø5.5mm



Pilot  
**1624-60**  
Ø 1.8mm

Drill Bur  
**1624-61**  
Ø 2.0mm

Drill Bur  
**1624-62**  
Ø 2.3mm

Drill Bur  
**1624-63**  
Ø 2.5mm

Drill Bur  
**1624-64**  
Ø 3.0mm

Drill Bur  
**1624-65**  
Ø 3.3mm

Drill Bur  
**1624-66**  
Ø 3.5mm

Drill Bur  
**1624-67**  
Ø 4.0mm

Drill Bur  
**1624-68**  
Ø 4.3mm



Drill Bur  
**1624-69**  
Ø 4.5mm

Drill Bur  
**1624-70**  
Ø 5.0mm

Drill Bur  
**1624-71**  
Ø 5.3mm

Drill Bur  
**1624-72**  
Ø 5.5mm

Parallel Pin (4 Pieces)  
**1624-80-81-82-83**

- Groove Depth Markings To Indicate Depth At 3, 5, 8, And 10mm
- Total Length: 22mm
- Side 1:
  - Apical Diameter: 1.5mm
  - Coronal Diameter: 2.5mm
- Side 2:
  - Apical Diameter: 2.5mm
  - Coronal Diameter: 3.5mm



**1624-04KT**  
The Osseodensification  
Burs Kit (17 Pieces)



**1624-05KT**  
Drills Stopper Kit  
(36 Pieces)

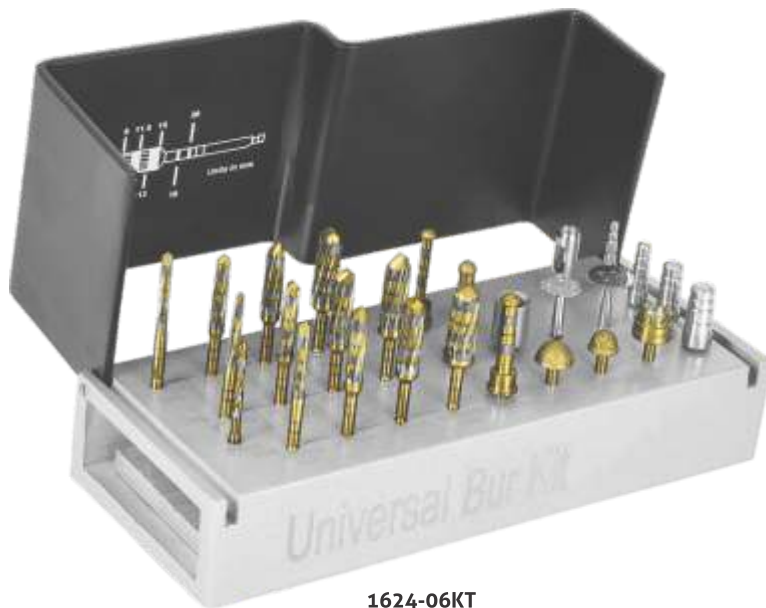

**1624-06KT**  
Universal Osseodensification  
Burs Kit (29 Pieces)



**1624-07KT**  
Osseodensification Burs Kit  
with Stopper (21 Pieces)



**1624-08KT**  
Faster Surgical Drills Kit  
(16 Pieces)



**1624-09KT**  
Saw Disk Kit (6 Pieces)  
3 Disks 10mm  
3 Disks 7mm



**1624-10KT**  
Surgical Drill Kit  
(16 Pieces)



**1624-12KT**  
Dental Implants Drills Kit  
(8 Pieces)



**1624-13KT**  
Conical Stopper Drills Kit  
(30 Pieces)



**1624-14KT**  
Compact Organized Conical Kit  
(15 Pieces)



**1624-15KT**  
Drivers Kit  
(8 Pieces)



**1624-16KT**  
Mini Drivers Kit  
(7 Pieces)



**1624-17KT**  
Bone Expander Kit  
(12 Pieces)



**1624-18KT**  
Bone Expander Kit  
(12 Pieces)



**1624-19KT**  
Bone Compression Kit (13 Pieces)



**1618-20KT**  
Bone Compression Screws Kit (5 Pieces)  
Bone Compression Screw  
1.8/2.8mm, 1.9/3.6mm, 2.4/4.1mm  
Sinus Elevation Screw 3.5mm



**1624-21KT**  
Bone Collector Kit (13 Pieces)  
Bone Chip Maker Drills  
Ø2mm, Ø3mm, Ø4mm, Ø5mm  
4 Pcs 5mm Stopper  
4 Pcs 10mm Stopper



**1624-22KT**  
Faster Bone Collector Kit (9 Pieces)



**1624-23KT**  
Universal Prosthetic Kit  
(17 Pieces)



**1624-24KT**  
Faster Trimmer Kit  
(14 Pieces)



**1624-25KT**  
Implant Screw Driver Kit  
(6 Pieces)



**1624-26KT**  
Drill Guide and Implant Positioning Kit (10 Pieces)  
Pilot Drill Diameter 2mm  
Drill Guide and Guid Pin Diameters  
6mm, 7.5mm, 9mm, 10.5mm, 12mm



**1624-27KT**  
Implant Positioning Kit  
(17 Pieces)



**1624-28KT**  
Implant Removal Kit  
(18 Pieces)